

New gTLD Implementation Model



New gTLD Program Goals

- Launch a process to introduce new gTLDs into the Domain Name Space following the direction provided by ICANN's GNSO policy recommendations, specifically
- Provide a timely, clear roadmap for applicants describing the application and evaluation process
- Preserve DNS stability and security

Caveat

- The implementation model is just that, a model.
- There has been considerable implementation work done at the direction of the ICANN Board while the Board considers the Policy Recommendations
- The actual implementation may vary from what is presented here

Aspects of the Process

- Simple process in most cases:
 - 5-step inquiry
 - Objective criteria
- Robust process when it needs to be:
 - Provide a path for addressing objections on specific limited grounds to proposed TLDs
 - Resolve situations where there are multiple applications for the same (or very similar) TLDs

Simplified Process

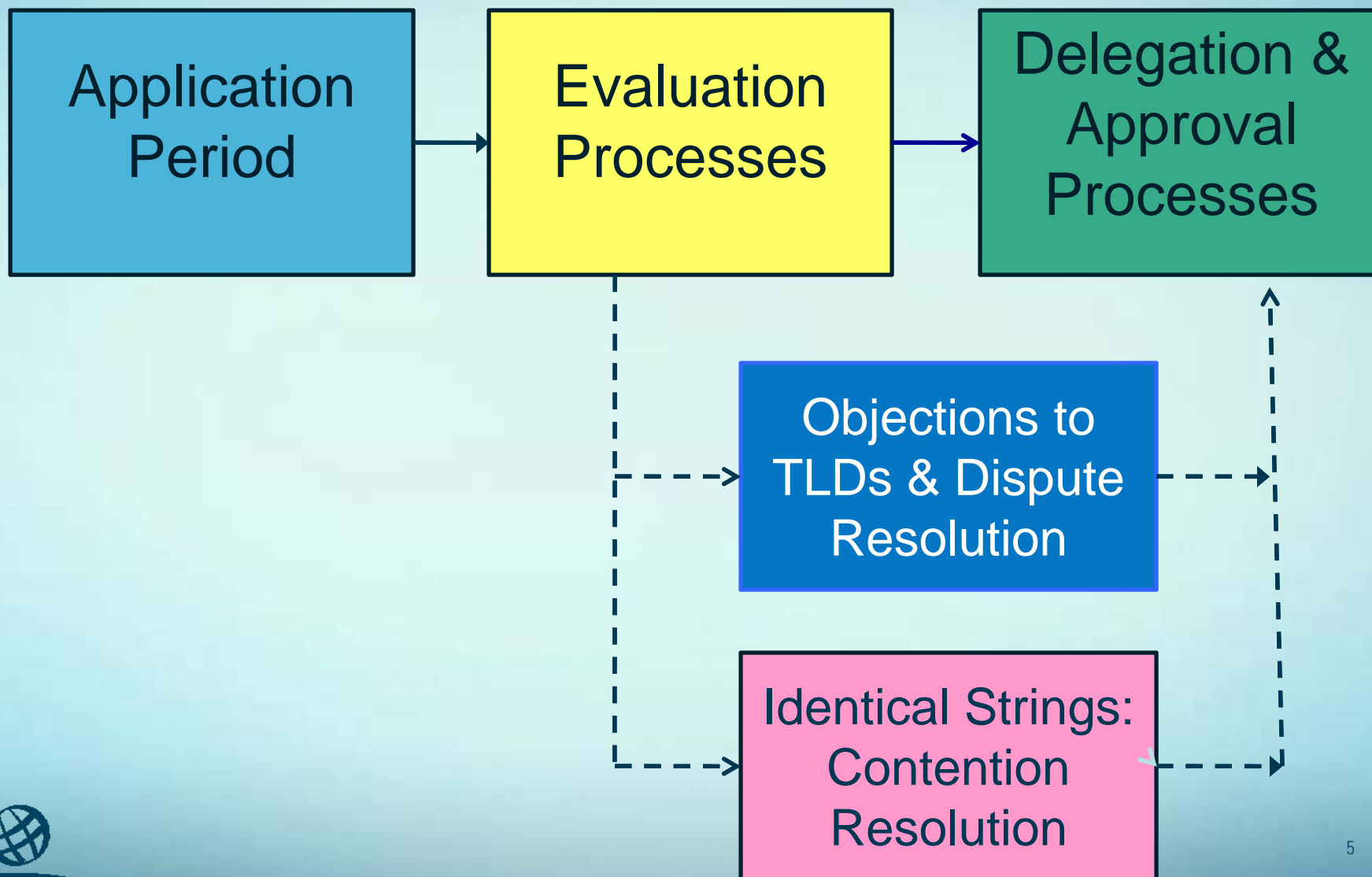

Fastest Potential Path of an Application

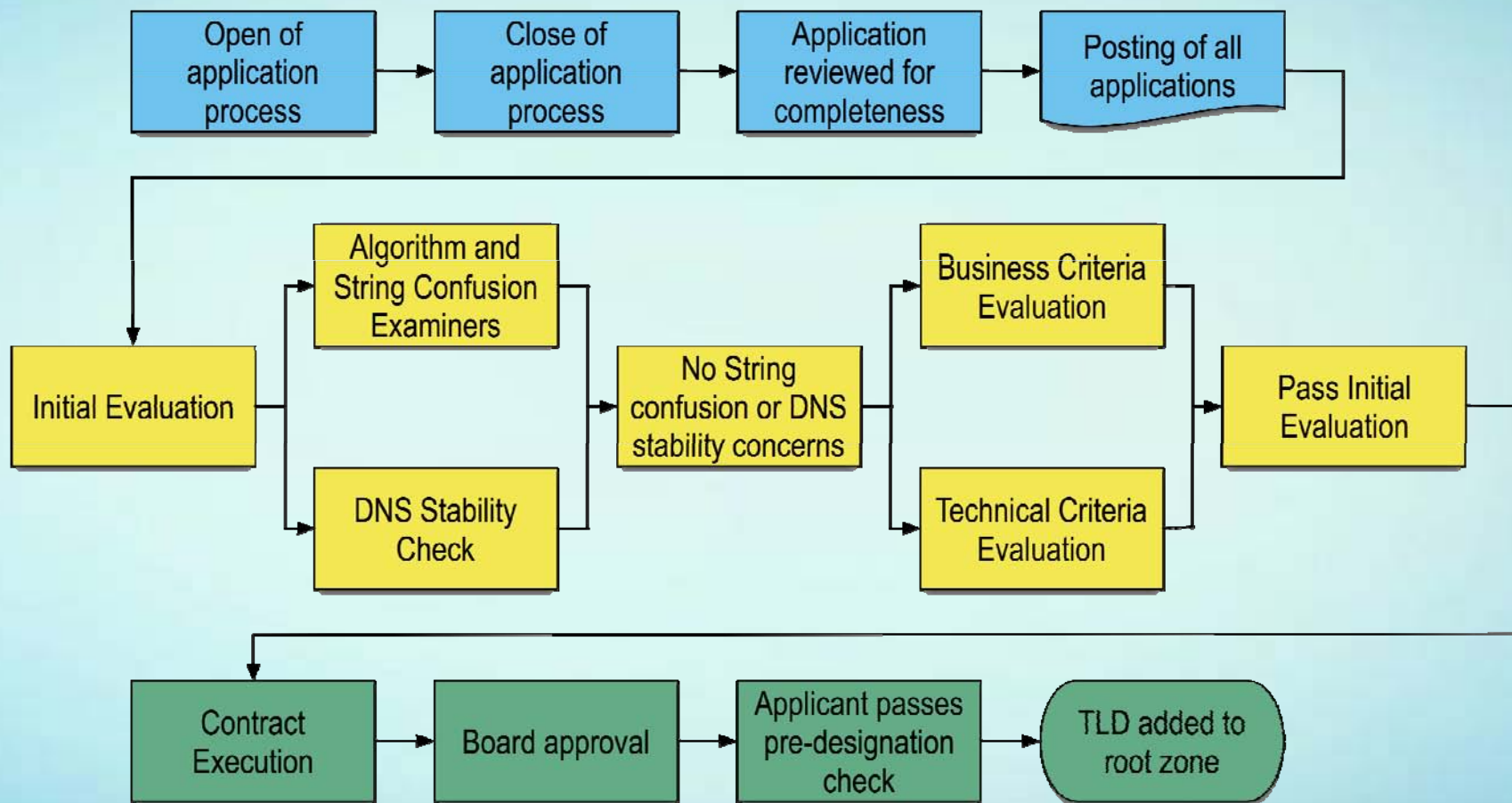

Main Application Paths

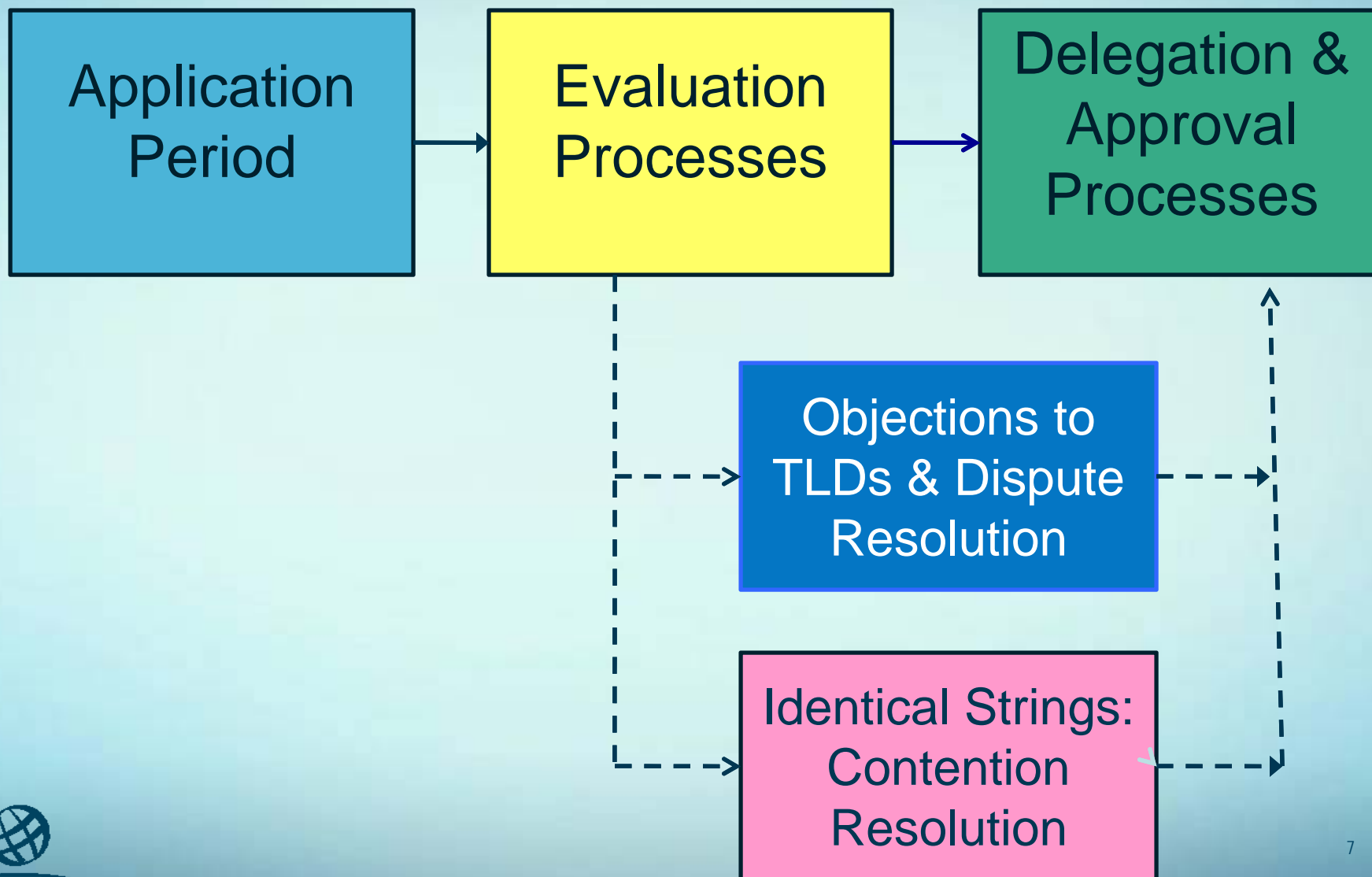

Application Phase

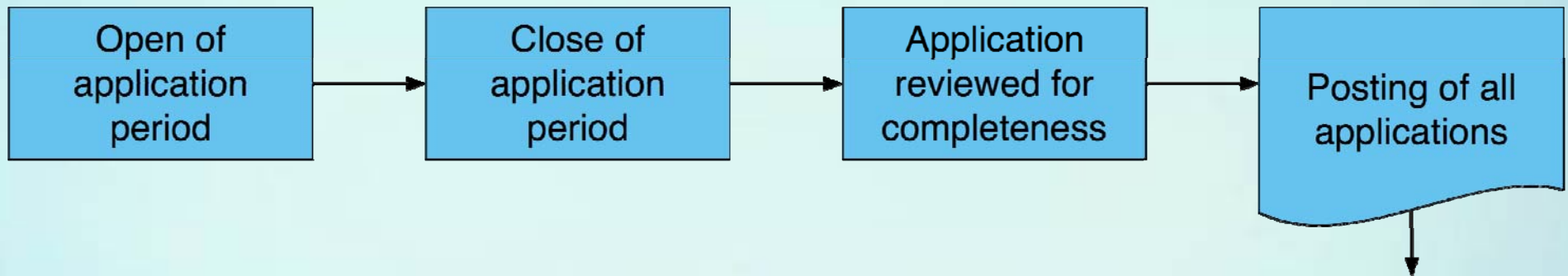

Application Period

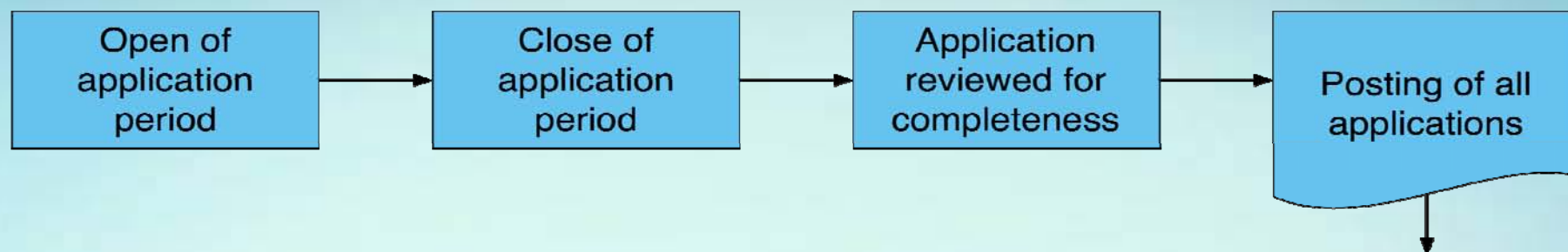

- Expected to last at least 45 calendar days
- Will follow 4-month communications period
- Applications will be reviewed for completeness
- Information on all applications will be posted on ICANN's website at the same time
- Fees:
 - Application
 - Additional → depending on application path

Types of Applicant

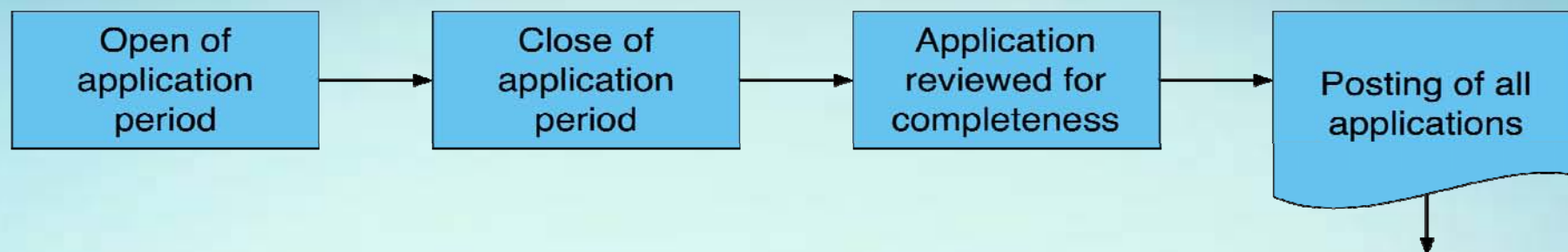

- Open:
 - Names generally available to any type of registrant
- Community-based:
 - Addresses a clearly identified, organized and pre-established community with finite membership
 - Is endorsed by that community
 - Features a string that is strongly and specifically associated with the community in question
 - Has a dedicated registration and use policy

Main Application Paths

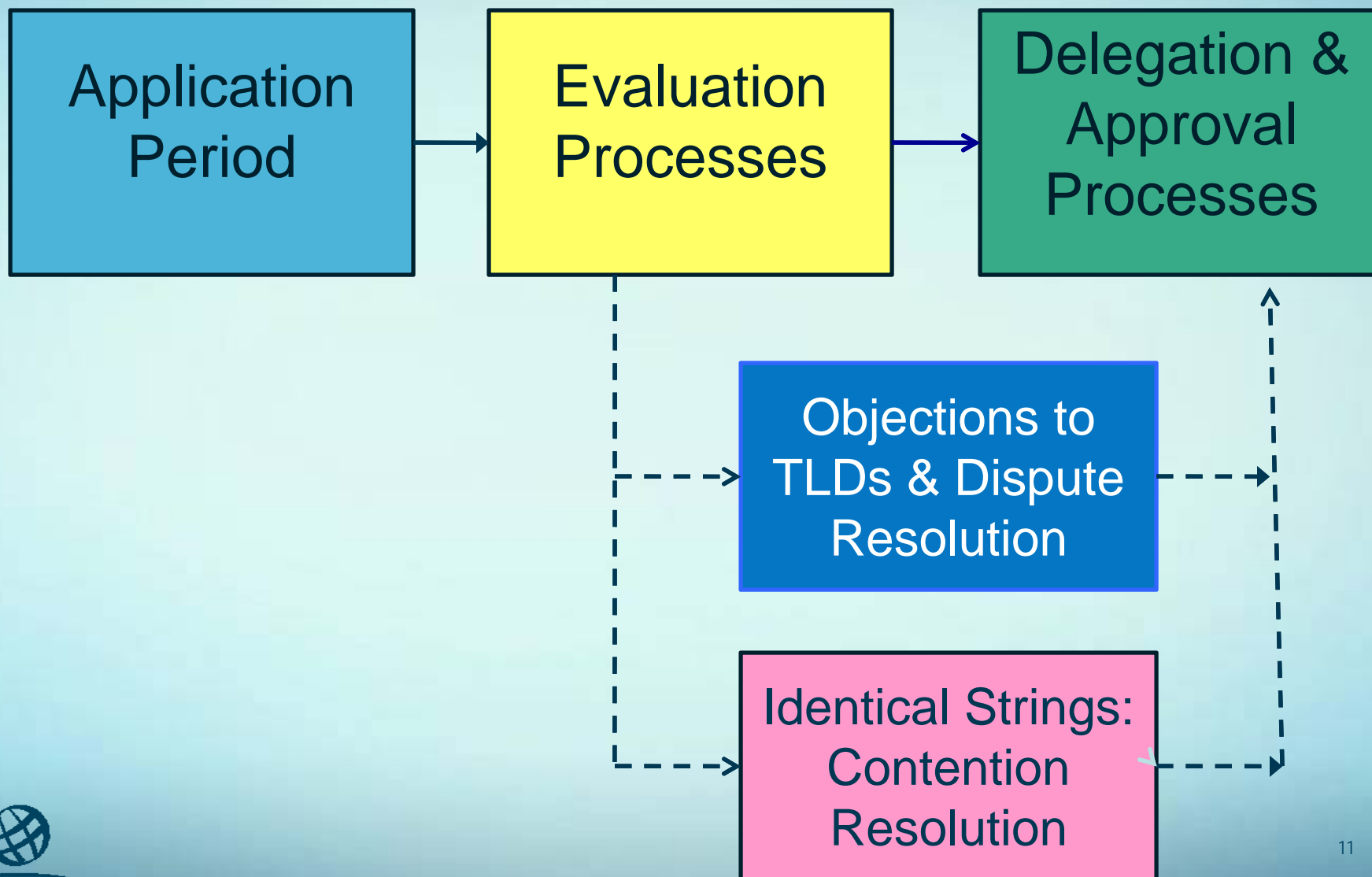

Initial Evaluation Phase

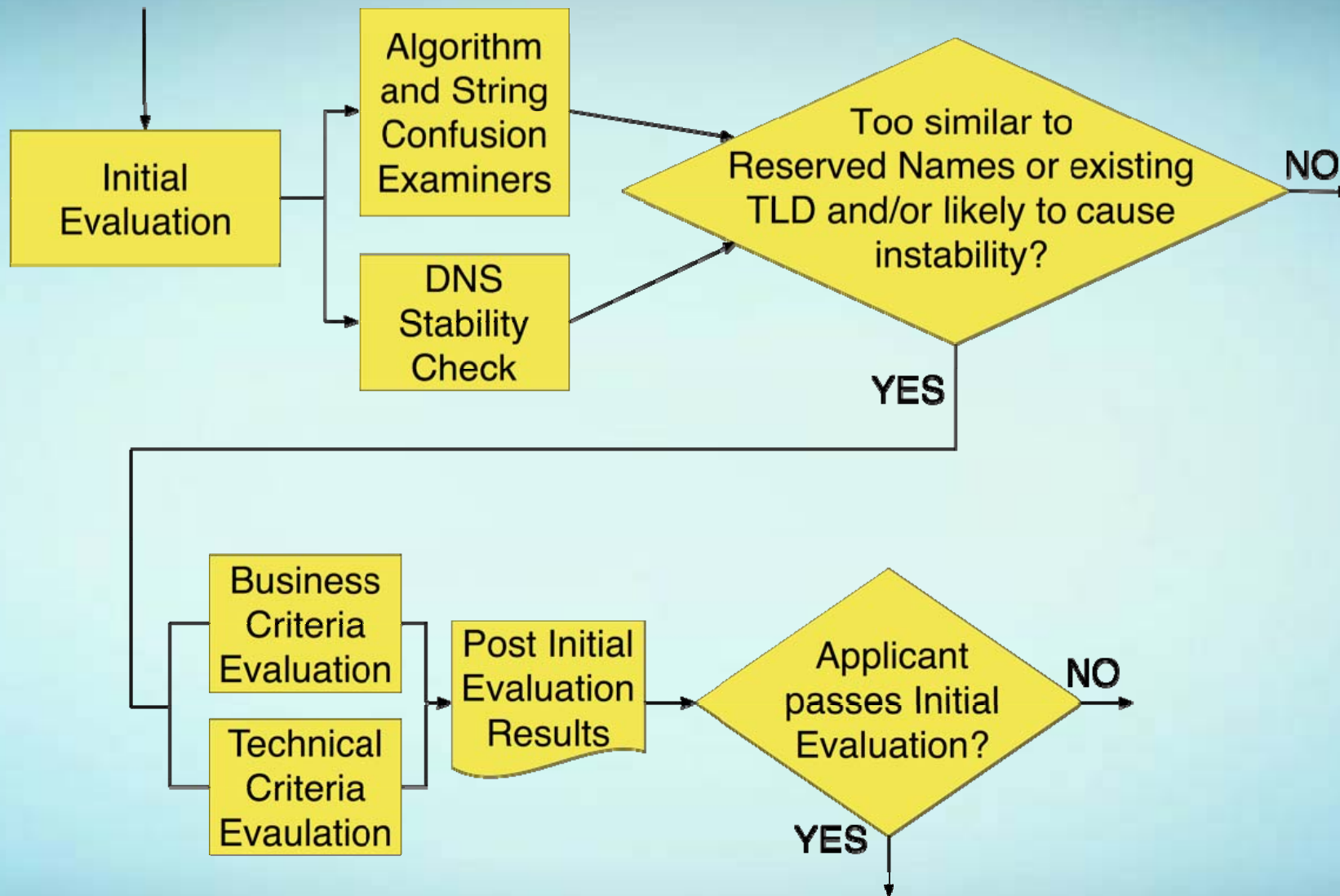

Initial Evaluation – TLD String

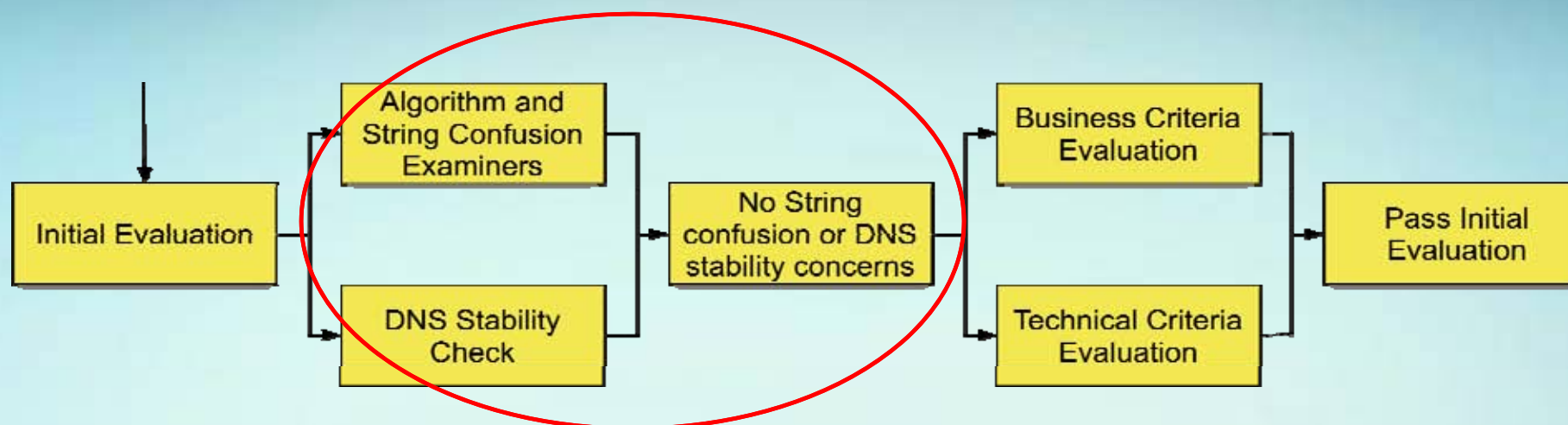

- TLD strings need to follow DNS stability rules
 - ASCII rules already published
 - Additional IDN rules under consideration
- Strings checked for similarity
 - Examiners decision informed by algorithm
 - Existing TLDs, reserved names
 - Other TLD strings applied for → String Contention¹³

Initial Evaluation – Applicant

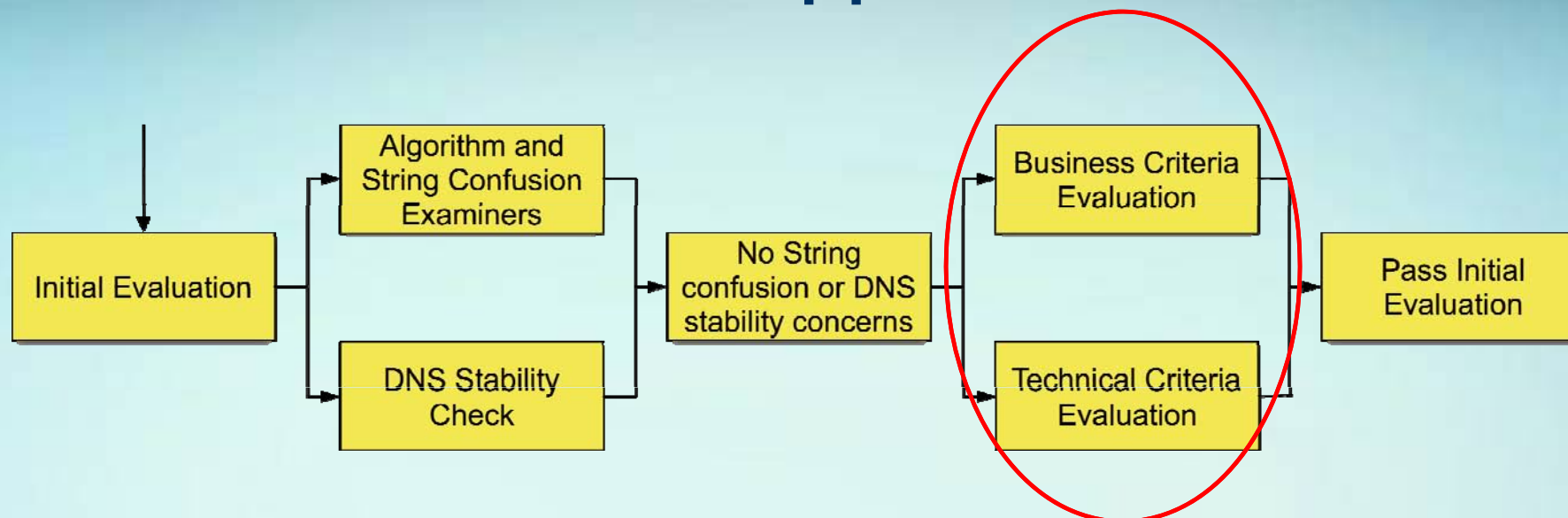

- Applicants are established organizations
- Technical evaluation: Applicant must demonstrate its competence to operate a registry in compliance with industry protocols and standards
- Operational / business evaluation: Applicant must demonstrate its capability to operate a stable registry

Extended Evaluation

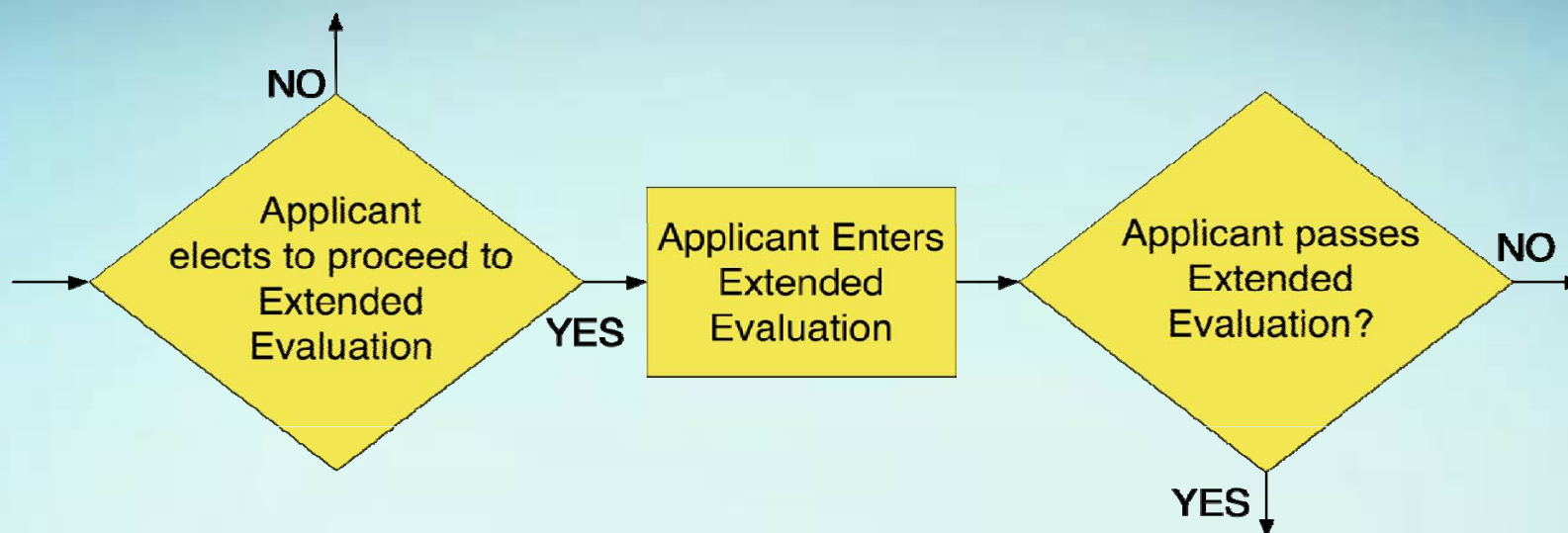

- An applicant who does not pass Initial Evaluation may appeal this decision by requesting additional review —→ Extended Evaluation
- One additional iteration takes place between applicants and evaluators to clarify information in the application and allow further examination of issues
- Same baseline criteria will be used

Main Application Paths

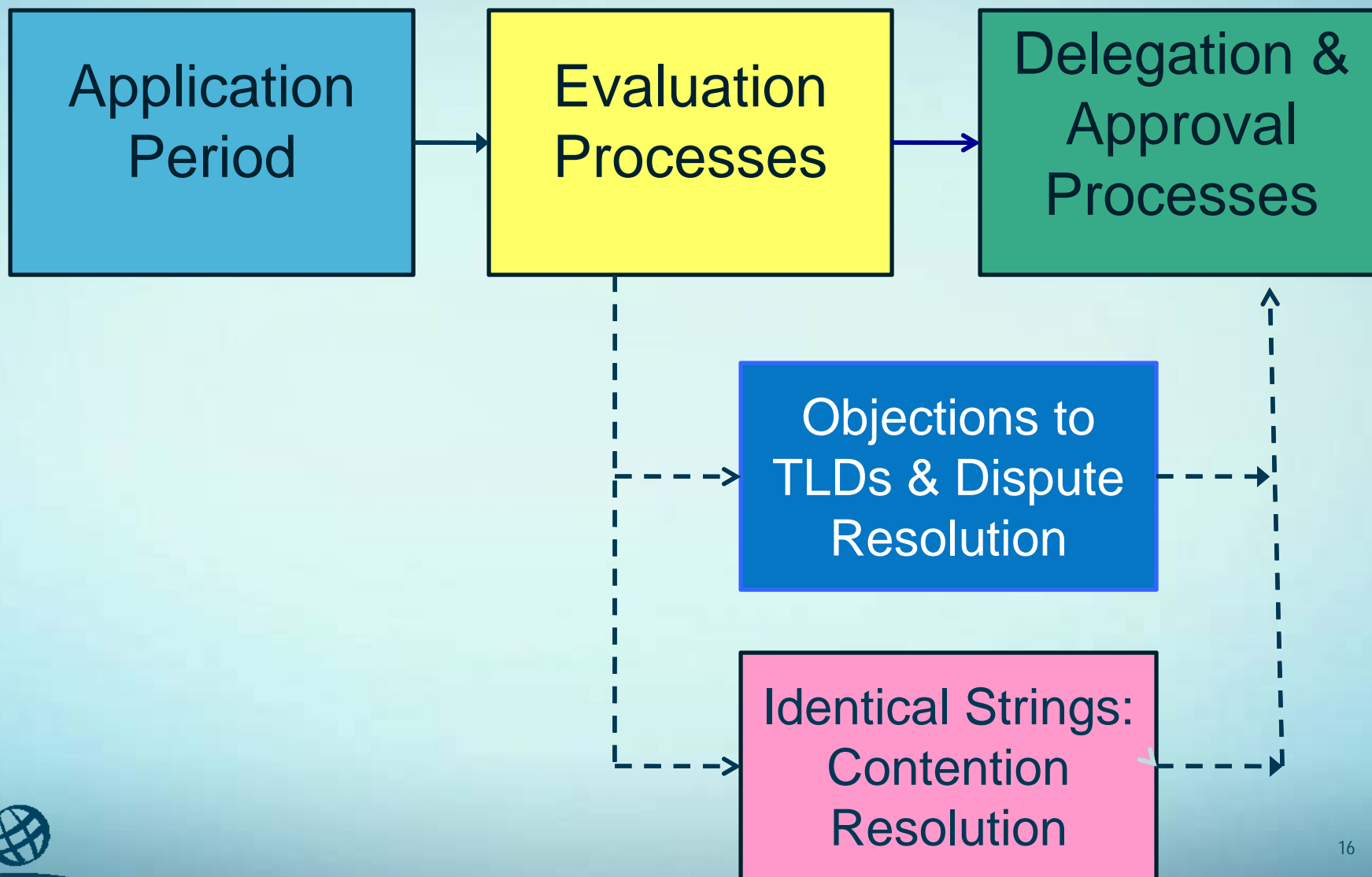

Dispute Resolution Phase

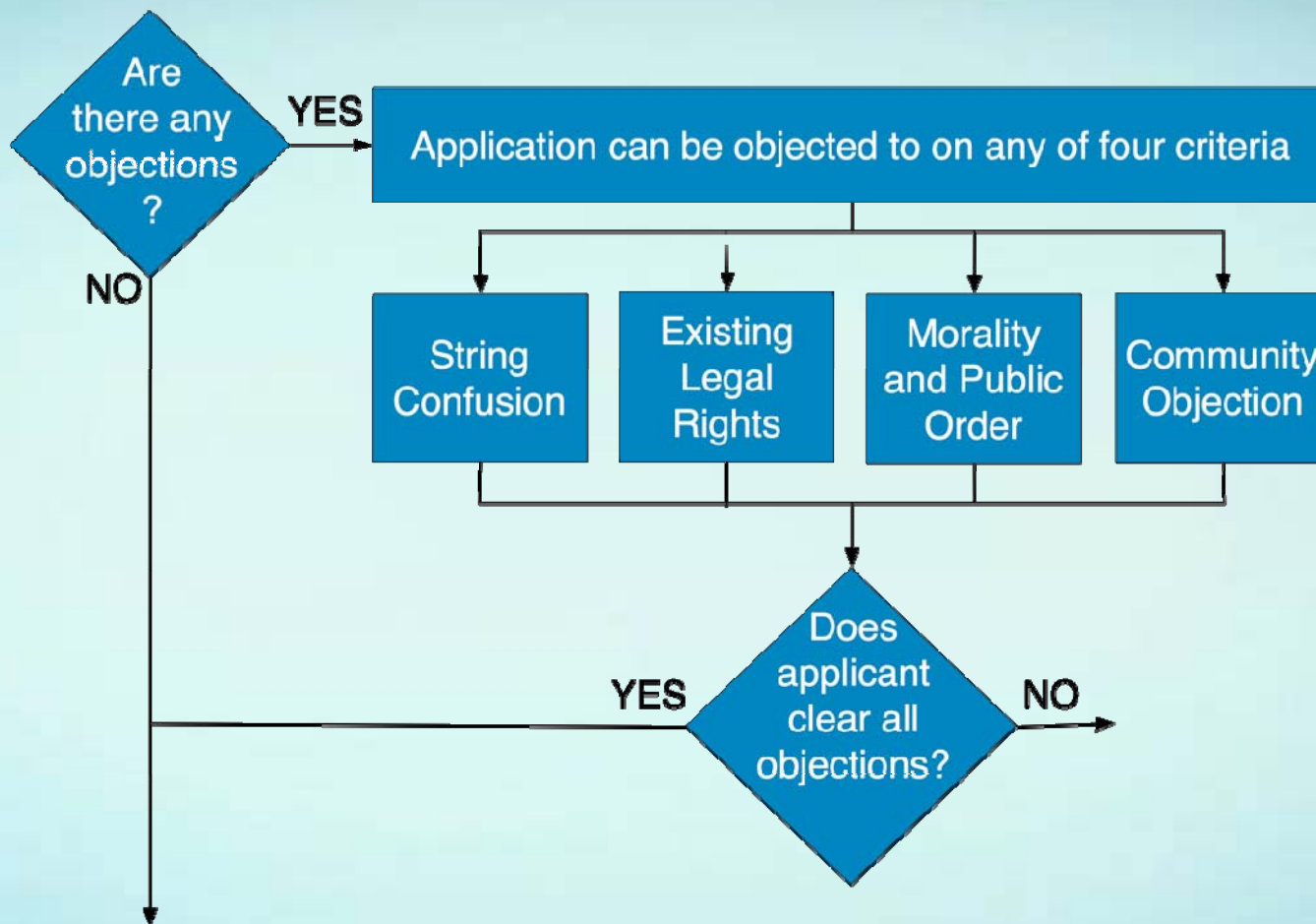

Interests Protected in the Process

- User confusion should be avoided
- Protection of intellectual property rights
- Morality & public order safeguards
 - Interests of governments
- Protection of community interests
 - Religious organizations
 - Geographically based communities
 - Indigenous groups

Dispute Resolution Phase

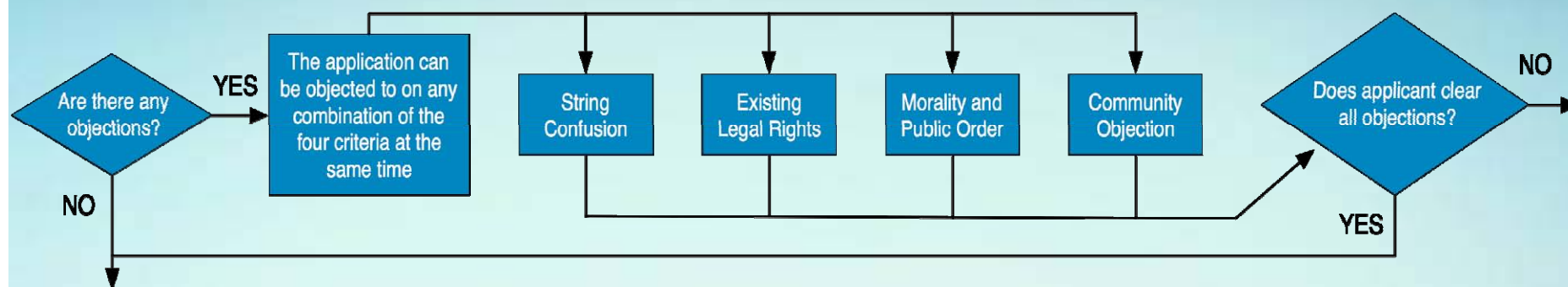

- Formal objections can be filed during a pre-determined period of time
- The dispute between the objector and applicant will be resolved by independent dispute resolution providers (DRPs)
- Fees will be paid directly to the DRPs

Dispute Resolution Process

- Only one dispute resolution service provider will be designated to administer all objections filed under any particular grounds for objection
- ICANN is working toward agreements with independent, internationally-recognized dispute resolution providers (DRPs) to administer the objection and dispute resolution proceedings
- DRPs will work with ICANN to adapt draft procedures and refine standards/guiding principles
- If more than one objection on the same grounds is filed against the same application, the intent is that those proceedings would be consolidated

Main Application Paths

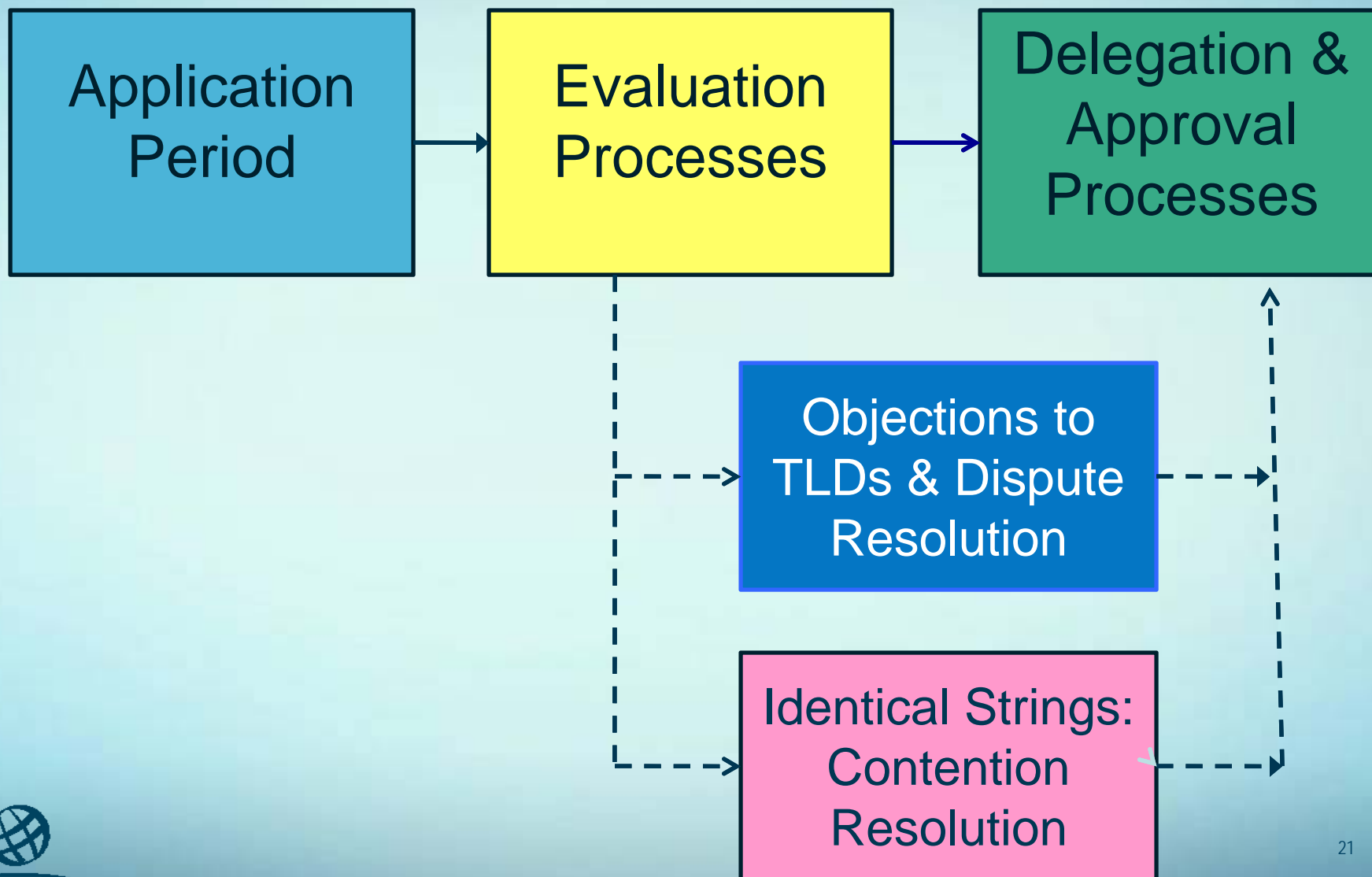

Resolving Contention Between Identical / Similar Strings

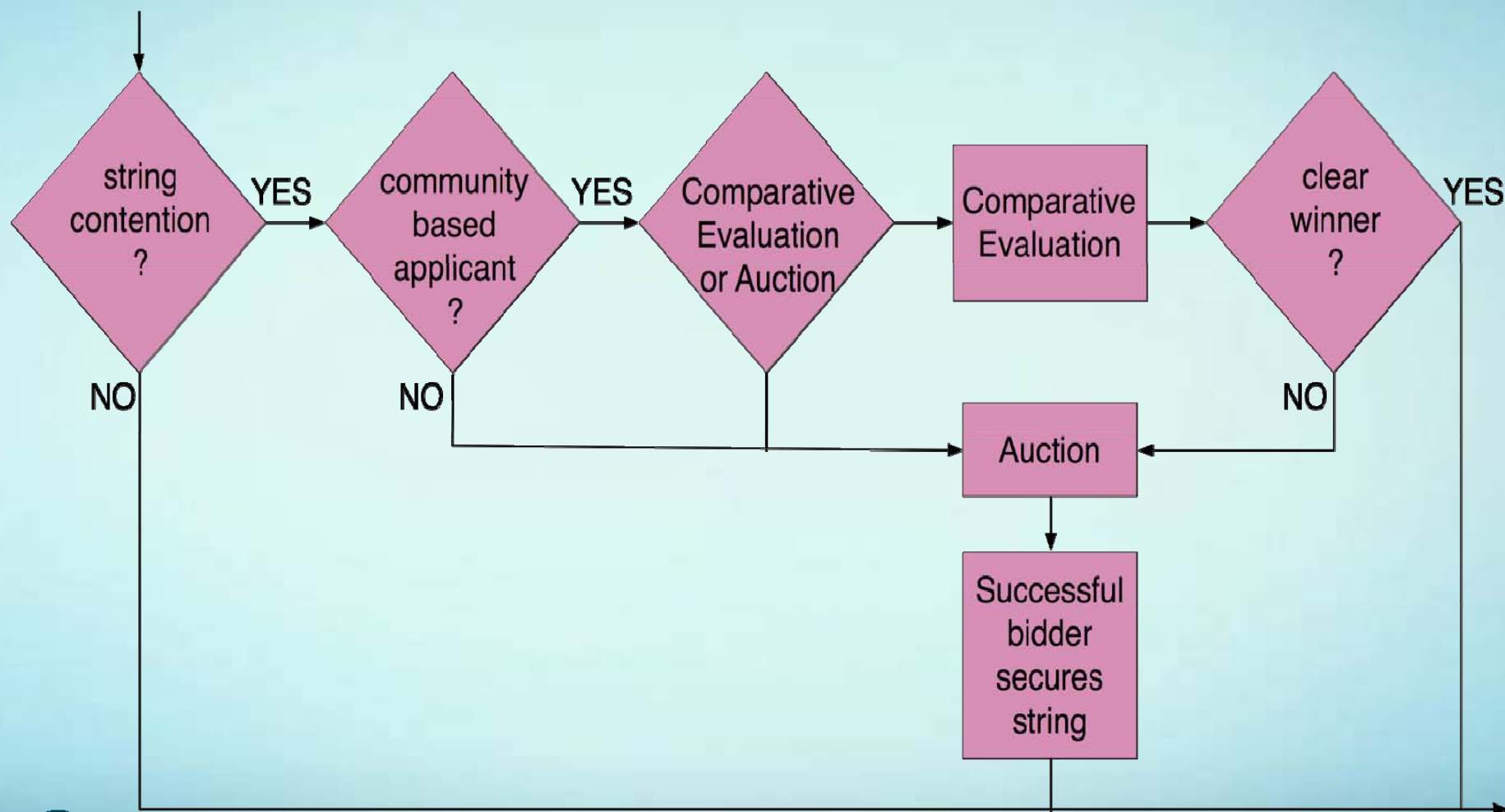

Resolving Contention Between Identical / Similar Strings

- Occurs when two or more TLD strings that remain after the evaluation and objection stages are identical or result in string confusion
- Applicants will be informed about the contention be given time to mutually resolve it
- Applicants will enter either into comparative evaluation or an auction process

Community-Based Applicants & Comparative Evaluation

- The Policy Recommendations established a preference for community-based applicants
- A bona fide community-based applicant can elect to have contention resolved through a comparative evaluation
- Winner should clearly and convincingly add more value to the global Internet namespace than other contenders
- If no clear winner, parties may proceed to auction

Auction: to resolve string contention

- Economic case for auctions paper to be published
- Different potential auction models are under investigation
- Auction process will be managed by a third party service provider
- Before an auction is conducted, ICANN will undertake a community-based consultation to determine uses of funds consistent with ICANN's mission and for the benefit of the DNS and DNS community

Delegation Phase

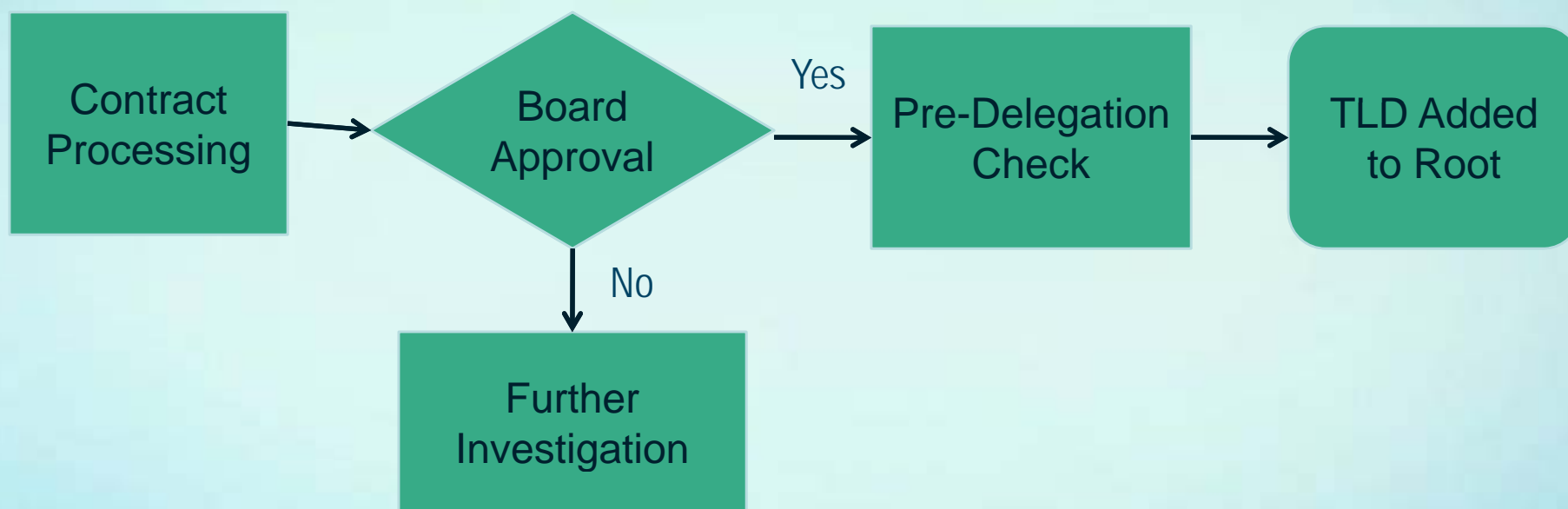

Pre-Delegation Steps

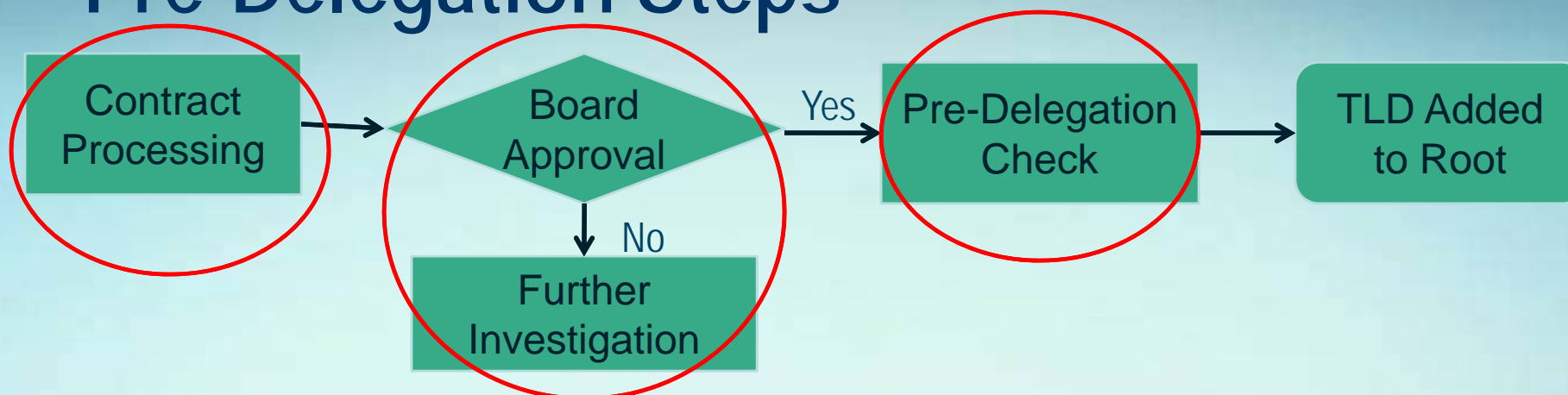

- Standard base agreement will be part of RFP
- Staff will recommend Board approval of applicants that have followed the standard process
- Actual delegation of a new gTLD to a successful applicant is contingent upon the applicant's demonstration, to the extent possible, that it has fulfilled the commitments required to meet the baseline criteria
- Pre-determined period of time to make all necessary structural arrangements for the pre-delegation phase

Anticipated Timeline

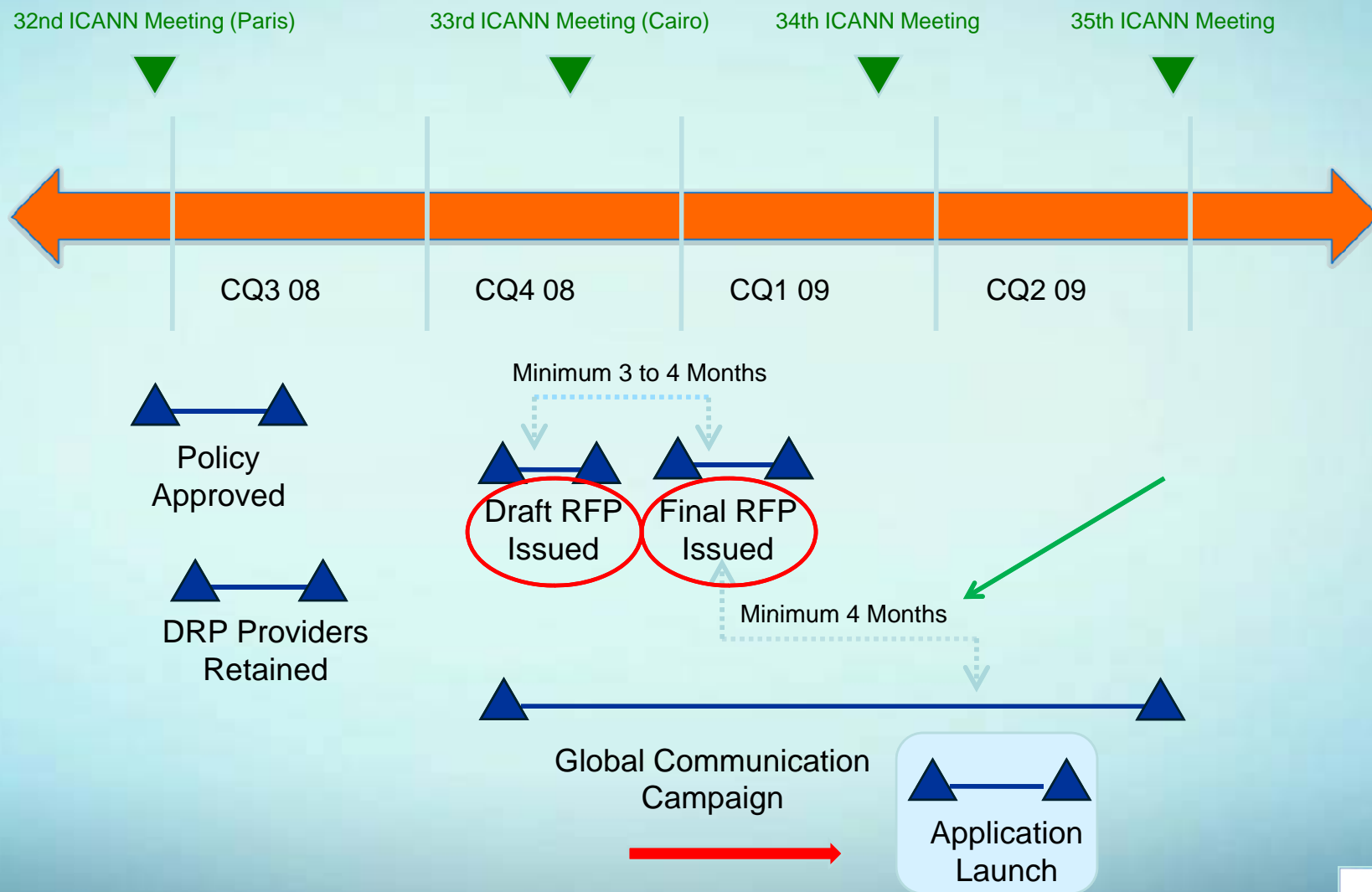

Thank You